

Flexy Compact

Bain-marie air ventilated, one well (4GN) H=900mm, overshelf with LED lights

ITEM # _____

MODEL # _____

NAME # _____

SIS # _____

AIA # _____

322083 (F03H4AF01W)

Bain-marie on cupboard, air ventilated, one well (4 GN container capacity) with overshelf with LED lights and one stainless steel tubular tray slider on customer side, H=900mm

Short Form Specification

Item No.

Compact design, ideal for space saving environments. Stainless steel tubular tray slider on customer side. Unit mounted on 150 mm high feet. Soft closing doors on operator side. Underneath ambient cupboard with doors. L type AISI 304 overshelf equipped with LED lights designed for extra increased visibility on the surface for charming food display. Sleek, minimalist glass structure, food and dust does not get trapped and easy to clean. Flat glass to be used as a service shelf for operator type of service, fully closed glass on customer side. Sturdy body construction with laminated panelings on 4 sides. Designed to serve the food in gastronorm containers with a maximum height of 150mm. Electronic overheating protection. Digital control with temperature display with precise adjustment (0,1°C). Fully compliant HACCP digital controls include visible alarms. A constant flow of hot air circulating through the containers guarantees the correct food temperatures. Temperature uniformity and 90% faster warm up time are guaranteed thanks to heavy duty armored heating elements and powerful radial booster fans. The system operates without water and ensures 35% energy efficiency when compared to standard bain-marie heating. Since the water is not needed to heat the well, the system guarantees easy of use and maintenance and there is no calcification of the resistances. No water consumption means less operating costs. Wells in 304 AISI stainless steel with rounded corners to facilitate cleaning operations and also equipped with a drain hole. 19mm thick glass wool isolated with galvanize sheet guarantees excellent well insulation to reduce energy dispersion. Food introduced at the correct

temperature maintains its core temperature according to Afnor Standards. 900mm worktop height.

Main Features

- Electronic overheating protection.
- Designed to serve the food in gastronorm containers.
- Precise temperature control and setting at 0,1°C .
- As standard the product comes with digitally controlled thermostat which is in line of HACCP norms and provides visual alarm as a warning of the increasing or decreasing temperatures.
- It is possible to transform one of the GNs to soup dispenser with the available accessory.
- CB and CE certified by a third party notified body.
- Tray slider in tubular stainless steel is installed on the customer side and it can also be folded down to facilitate passage of the units through doorways.
- Ideal for servery lines with an operator.
- Unit mounted on 150 mm high feet.
- Soft closing doors on operator side.
- Underneath ambient cupboard with doors ideal for extra storage.
- Available options with online configurator: colors, tray sliders, overshelves, feet/wheels with desired diameter, height 750mm for kids.
- Stylish L type overshelf designed for extra increased visibility on the surface for charming food display.
- Overshelf equipped with LED lights.
- Optional plinth can be installed to cover the feet or the wheels.
- Suitable for GN 1/1 containers with a maximum height of 150 mm.
- Available drop-in dimensions: 1, 2, 3, 4, 5, 6 GN.
- A constant flow of hot air circulating through the containers guarantees the correct food temperatures. Temperature uniformity and fast warm up time are guaranteed thanks to heavy duty armored heating elements and powerful radial booster fans. Cylindrical stainless steel air diffusers provides a constant air circulation.
- Since the water is not needed to heat the well, the system guarantees easy of use and maintenance: there is no calcification of the resistances.
- No need extra connections for water, less work during installation/maintenance.
- Perfect compact design makes it ideal for space saving environments.
- Food introduced at the correct temperature maintains its core temperature according to Afnor Standards.
- Available dimensions: 2, 3, 4 GN.
- Thanks to the sleek, minimalist glass structure, food and dust does not get trapped and the cleaning is made easier.

Construction

- Heating elements connected to the well bottom include safety thermostat.

APPROVAL: _____

Sustainability



- 19mm thick rock wool isolated with galvanize sheet guarantees excellent well insulation to reduce energy dispersion.
- 90% fast preheating phase and no need for water (as traditional bain marie), reduces energy and no water consumption.
- The system operates without water and ensures energy efficiency when compared to standard bain-marie heating.
- No water consumption means less operating costs.

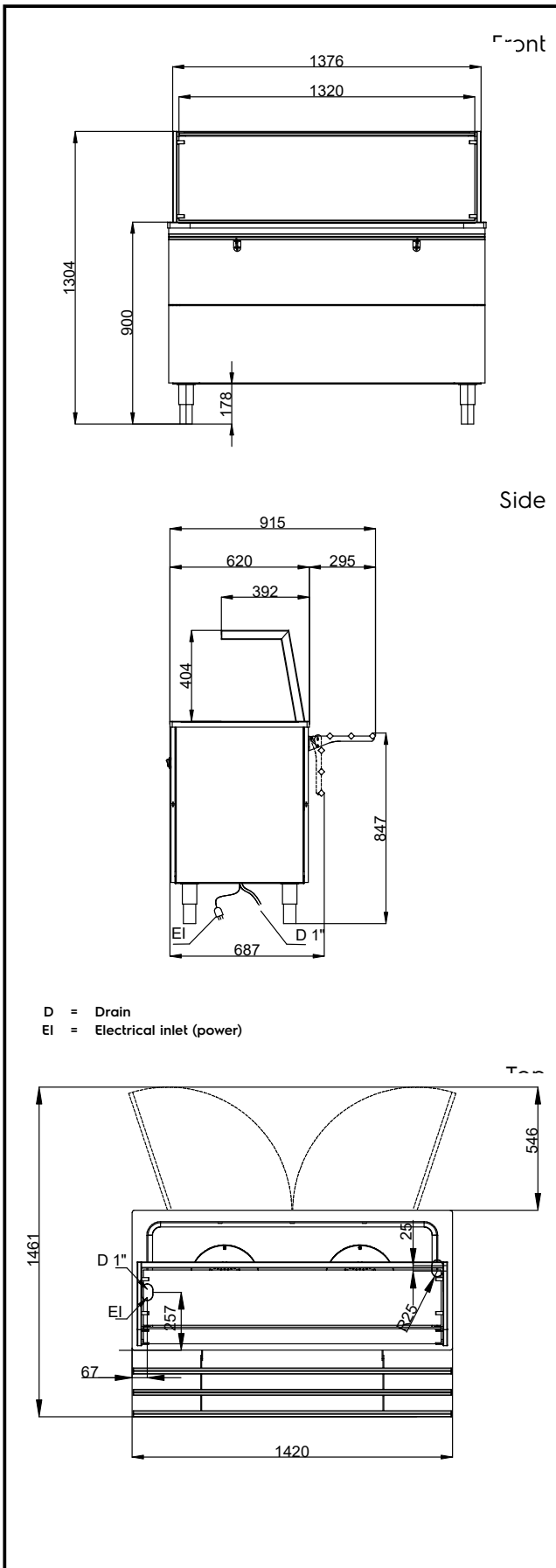

D = Drain
 EI = Electrical inlet (power)

Electric

Supply voltage:
 322083 (F03H4AF01W) 220-240 V/1N ph/50/60 Hz
 Electrical power max.: 2.11 kW

Key Information:

N° of doors: 2
 External dimensions, Width: 1420 mm
 External dimensions, Depth: 915 mm
 External dimensions, Height: 1304 mm
 Net weight: 138 kg
 Shipping height: 1430 mm
 Shipping width: 750 mm
 Shipping depth: 1460 mm
 Shipping volume: 1.57 m³
 Set temperature: +75 / +85 °C
 Height adjustment: -20/40 mm

Sustainability

Noise level: 59 dBA